

#### CORE SETS

##### Effective core parameters

SYMBOL	PARAMETER	VALUE	UNIT
$\Sigma (1/A)$	core factor ( $C_1$ )	1.73	$\text{mm}^{-1}$
$V_e$	effective volume	390.0	$\text{mm}^3$
$l_e$	effective length	26.0	mm
$A_e$	effective area	15.0	$\text{mm}^2$
$A_{\min}$	minimum area	15.0	$\text{mm}^2$
$W_t$	mass of core set	$\approx 2.7$	g

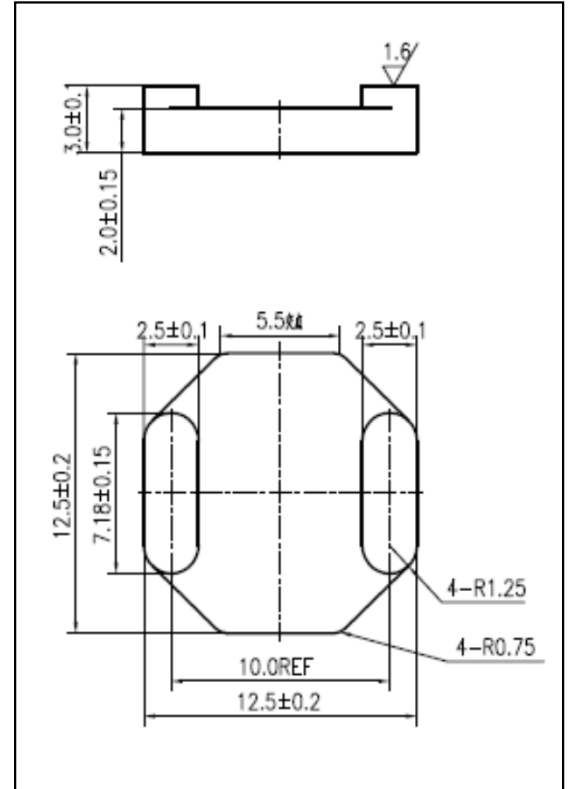

#### Characteristic

GRADE	AL ( $\text{nH/N}^2$ )	B (mT)	CORE LOSS (W)
	$f=10\text{KHz}$ $U=0.25\text{V}$	$H=250\text{A/m}$ $f=25\text{kHz}$ $T=100^\circ\text{C}$	$f=100\text{KHz}$ $B=200\text{mT}$ $T=100^\circ\text{C}$
DMR40	$1350 \pm 25\%$	$\geq 250$	$\leq 0.40$
DMR44	$1350 \pm 25\%$	$\geq 250$	$\leq 0.31$