

CORE SETS

Effective core parameters

SYMBOL	PARAMETER	VALUE	UNIT
$\Sigma (1/A)$	core factor (C_1)	3.02	mm^{-1}
V_e	effective volume	681.0	mm^3
l_e	effective length	45.4	mm
A_e	effective area	15.0	mm^2
A_{\min}	minimum area	15.0	mm^2
W_t	mass of core set	≈ 2.26	g

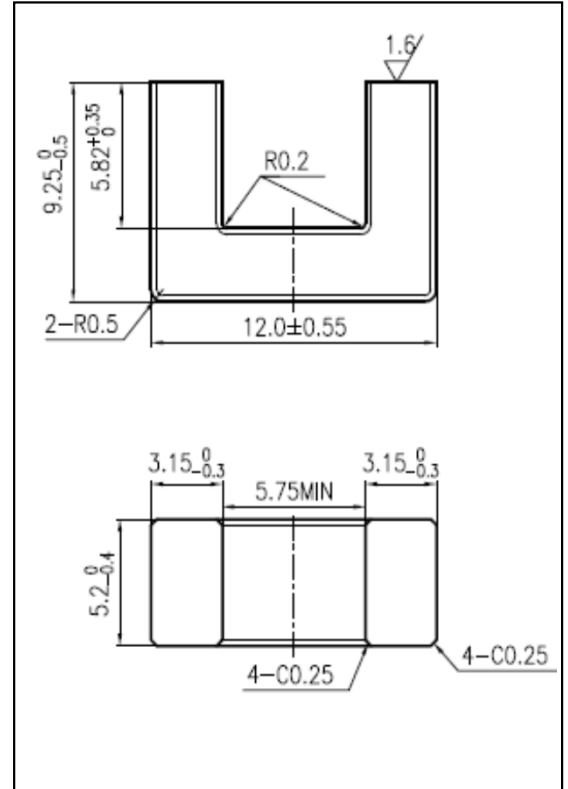

Characteristic

GRADE	AL (nH/N^2)	B (mT)	CORE LOSS (W)
	$f=10\text{KHz}$ $U=0.25\text{V}$	$H=250\text{A/m}$ $f=25\text{kHz}$ $T=100^\circ\text{C}$	$f=100\text{KHz}$ $B=200\text{mT}$ $T=100^\circ\text{C}$
DMR40	$800 \pm 25\%$	≥ 250	≤ 0.33
DMR44	$800 \pm 25\%$	≥ 250	≤ 0.26