

CORE SETS

Effective core parameters

SYMBOL	PARAMETER	VALUE	UNIT
$\Sigma (1/A)$	core factor (C_1)	0.39	mm^{-1}
V_e	effective volume	8322.0	mm^3
l_e	effective length	57.0	mm
A_e	effective area	146.0	mm^2
A_{\min}	minimum area	125.0	mm^2
W_t	mass of core set	≈ 47.7	g

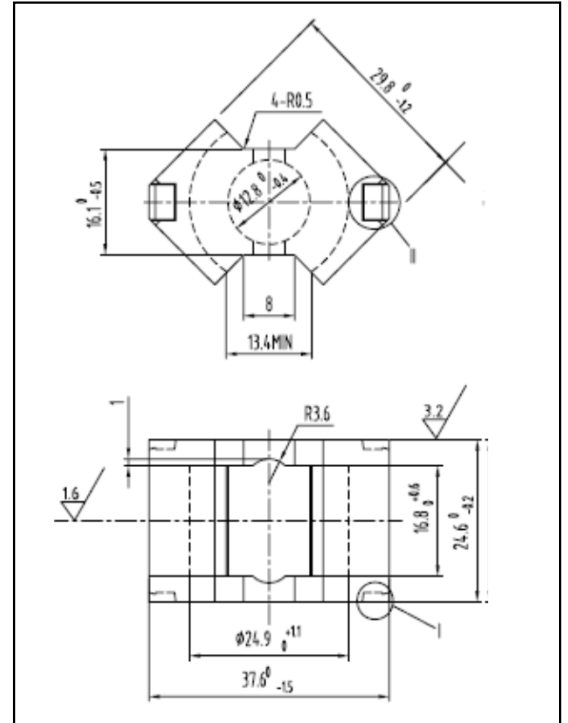

Characteristic

GRADE	AL (nH/N^2)	B (mT)	CORE LOSS (W)
	f=10kHz U=0.25V	H=250A/m f=25kHz T=100°C	f=100kHz B=200mT T=100°C
DMR40	$5200 \pm 25\%$	≥ 315	≤ 6.68
DMR44	$5200 \pm 25\%$	≥ 315	≤ 5.72
DMR47	$5400 \pm 25\%$	≥ 325	≤ 4.77
DMR95	$6800 \pm 25\%$	≥ 315	≤ 4.58