

CORE SETS

Effective core parameters

SYMBOL	PARAMETER	VALUE	UNIT
$\Sigma (1/A)$	core factor (C_1)	1.04	mm^{-1}
V_e	effective volume	145.14	mm^3
l_e	effective length	12.30	mm
A_e	effective area	11.80	mm^2
W_t	mass of core set	≈ 1.15	g

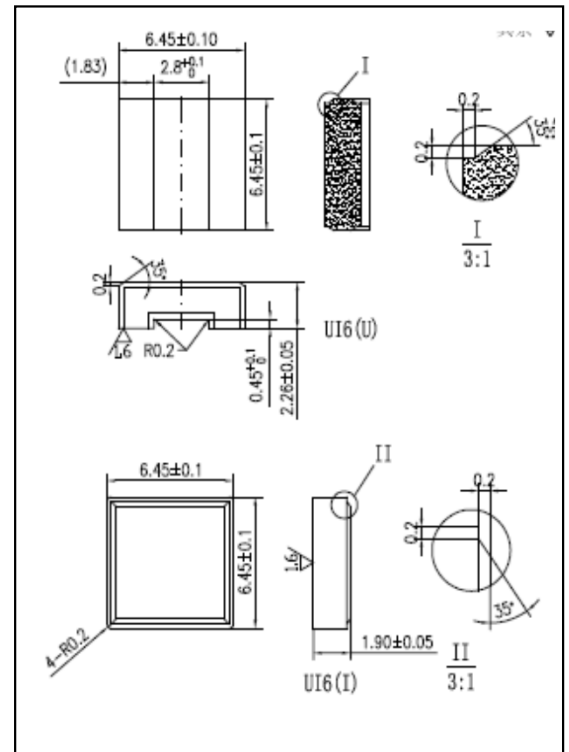

Characteristic

GRADE	AL (nH/N^2)	B (mT)	CORE LOSS (W)
	$f=10\text{kHz}$ $U=0.25\text{V}$	$H=250\text{A/m}$ $f=25\text{kHz}$ $T=100^\circ\text{C}$	$f=500\text{kHz}$ $B=50\text{mT}$ $T=100^\circ\text{C}$
DMR40	$1100 \pm 25\%$	—	—